



# VILPE® solutions for flat roofs



VILPE warranties:

**10** year  
colour  
warranty

**20** year  
technical  
warranty





**VILPE Oy**

**Sales & technical support**

Tel. +358 20 123 3222

E-mail: [sales@vilpe.com](mailto:sales@vilpe.com)

Kauppatie 9

FI-65610 Mustasaari, Finland

> **VILPE.COM**



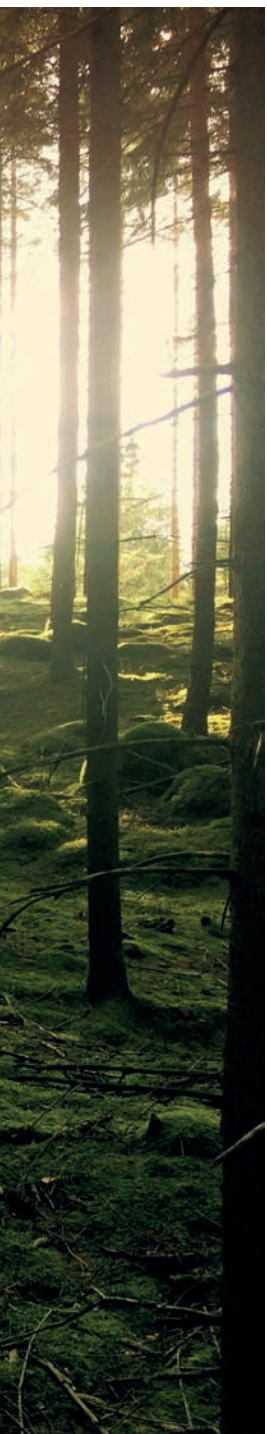

## CONTENTS

VILPE SENSE	4
VENTILATION OF ROOF STRUCTURES	6
Alipai negative pressure air vents	6
PASS-THROUGHS	8
Felt tall pass-throughs	8
315-630S FLOW pass-throughs	8
PASS-THROUGH SEALS	10
Felt pass-through seals	10
Vapour barrier seals	11
PVC roof pass-through seals	11
ROOF DRAINS	12
Roof drains of polypropylene	12
Acid-resistant stainless steel roof drains	13
FASTENERS	15
Croco fasteners	15
Croco tools	18
Power fasteners	19
VILPE OY	20

VILPE warranties:

**10** year colour warranty

**20** year technical warranty



## VILPE SENSE

### A smart system for humidity control

#### VILPE Sense prevents moisture damage

VILPE Sense is the first product on the market for both detecting and preventing moisture damage. The solution consists of VILPE's roof fan with an EC motor, combined with a control unit, mobile base station, and two or more sensors.

VILPE Sense detects damage or leakage in e.g. roof structures or base floors by measuring the relative humidity and temperature of the structures, which allows possible damage to be detected as soon as it occurs. The faster hidden damage or leakage is detected, the easier and cheaper it will be to repair.

The VILPE Sense system alerts you to humidity changes in the structures through an application in your phone or on your computer. The system also dries the insulation layer when necessary: for instance, after rain or during humid autumns, that can cause humidity damages even though there are no leakages in the structures.

#### How it works

The VILPE Sense basic kit mob. consists of two wireless sensors and a control unit, which are linked to an energy-efficient ECo roof fan and a mobile base station. All VILPE ECo roof fans can be combined with VILPE Sense. The system can be installed under pressure ventilation pipes so that the structures remain intact. Additional sensors can be added to the system. A SIM card is required for the function of the mobile base station and can be purchased either pre-installed, or separately.

One sensor monitors the temperature and relative humidity in the insulation layer, whilst the other measures that of the outdoor air. The data is sent to the control unit, then forwarded to the VILPE Sense mobile base station (sold separately) and uploaded to the VILPE cloud service, where it is analysed. The algorithm compares calculated absolute humidity levels in structures to outdoor air absolute humidity, and adjusts the VILPE ECo roof fan to the optimum

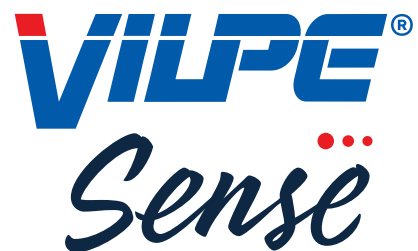

For more information, visit:

[VILPE.COM/EN/SENSE](http://VILPE.COM/EN/SENSE)

#### VILPE Sense

Product	Product No.
VILPE Sense basic kit mob.	735042
VILPE Sense sensor (additional)	735041
VILPE Sense mobile base station + SIM	735043
VILPE Sense mobile base station	735044
VILPE ECo Sense roof fan	741982



VILPE Sense basic kit mob.



VILPE Sense sensor  
(additional)



VILPE Sense mobile base station  
(+ SIM)



VILPE ECo Sense roof fan

fan level based on the ventilation demand. For example, if the system detects excess humidity in the insulation layer, the roof fan is automatically activated to work at a higher speed until the structure is dry. When excess humidity has been removed, the roof fan returns to the normal level.

## Benefits

The humidity management system of structures is part of responsible construction and property maintenance. The Sense system benefits property owners, housing company decision-makers and renovation companies. It enables accurate and systematic monitoring of the condition of roof structures and crawl spaces, as well as better drying of structures.

When problems are detected in time, the need for unanticipated and costly renovations is reduced or even eliminated.

Repairs can be directed immediately to the right place, so they are cheaper and faster to implement. Studies or repairs of structures do not need to be conducted on the basis of guesswork alone – objective, measurable data is available to support decision-making. Repair needs are also easy to assess in advance and repairs can be carried out systematically.

Insulation layers and structures are automatically ventilated, for example, after rain. This prevents the formation of mould or fungi in the structures. The insulation layer performance will also be better – moisture in the insulation layer significantly reduces its insulation capacities, which increases energy consumption in the building.

VILPE Sense prevents moisture damage even during construction, when structures are exposed to varying weather conditions.

The system also increases the resale value of the property. For sales purposes, the condition of the property can be proved with reliable data. The need for difficult roof structure inspections can be reduced.

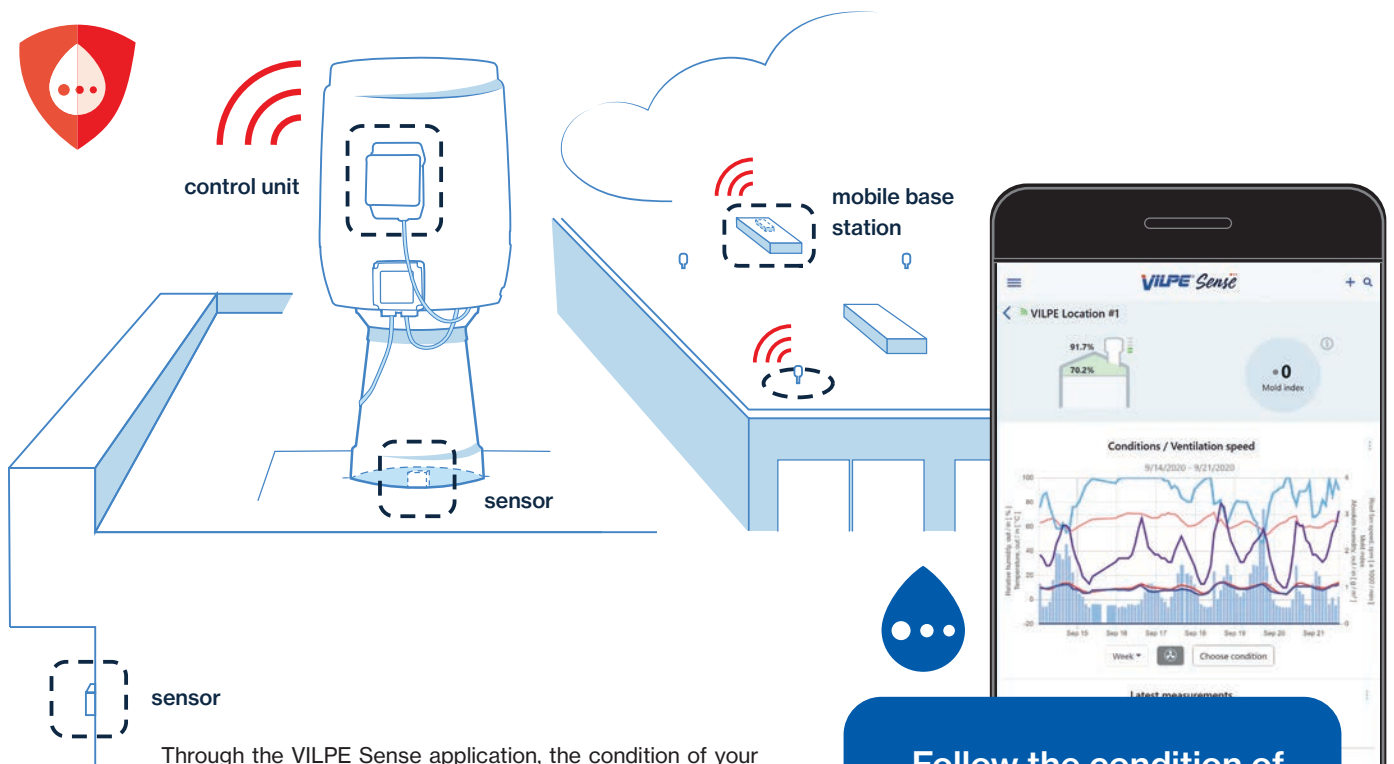

Through the VILPE Sense application, the condition of your building can be checked at any time, and the system will automatically alert you in cases of potential leakage. This data can also be safely exported to any complete home automation system. Users can follow the temperature, relative humidity, absolute humidity, mould index and roof fan motor speed.

Follow the condition of your roof in the VILPE Sense application

# VENTILATION OF ROOF STRUCTURES

## Alipai underpressure vents

ALIPAI negative pressure air vents allow the roof to breathe

Alipai negative pressure air vents ventilate the roof structures and ensures efficient removal of moisture. Moisture is accumulated in wood, concrete and other building materials during the building phase. Moisture can also derive from leaks in structures.

If the roof is not ventilated properly, moist air that arises from the building to the roof can condense and cause moisture in the thermal insulation of the roof. During winter, this moisture can freeze and the thermal insulation loses its insulating properties, which in turn can result in a significant rise in heating costs. Excessive moisture promotes the growth of fungi, moulds and micro-organisms, damaging the structures of the house. With Alipai vents, the thermal insulation of the roof remains dry, the indoor air quality is improved and the heating costs become lower.

## Production materials

Alipai vents are made from noncorrosive, weatherproof and impact proof, recyclable polypropylene plastic (PP), which is coloured black throughout. Also, the plastic is UV protected, meaning that the sun will not cause any colouring defects. The material is chemically neutral and endures continuous exposure to temperatures from  $-30^{\circ}\text{C}$  to  $+80^{\circ}\text{C}$ , temporarily from  $-40^{\circ}\text{C}$  to  $+120^{\circ}\text{C}$ .

In contact with silicon, the material loses its functionality. The products must not be cleaned with detergents containing silicon nor must they be stored in places where silicon aerosols are used.

## Applications

Alipai negative pressure air vents are available for the low-pitched, inclined and ridge sections of low-pitched roofs. Alipai ridge negative pressure air vents are intended for the ridges of low-pitched roofs. The angle of the flange makes it possible to install the low pressure air vent to the ridge, ensuring improved ventilation of the roof. The flange is installed, following exactly the shape of the ridge, whereby the installation is tight and durable.

The amount of Alipai negative pressure air vents per roof area depends on the target building, materials used and building regulations and should be estimated by the construction supervisor. However, as a general guideline one Alipai 75 covers a roof area of approximately  $75\text{ m}^2$ , one Alipai 110 approximately  $100\text{ m}^2$  and one Alipai 160 approximately  $150\text{ m}^2$ . In the construction planning phase, it is important to ensure that no parts of the roof are left without ventilation and that the air can move freely.



VILPE Alipai 75  
negative pressure air vent



VILPE Alipai FLOW 110  
negative pressure air vent



VILPE Alipai FLOW 160  
negative pressure air vent



VILPE Alipai FLOW ridge 14



VILPE Alipai FLOW ridge 27

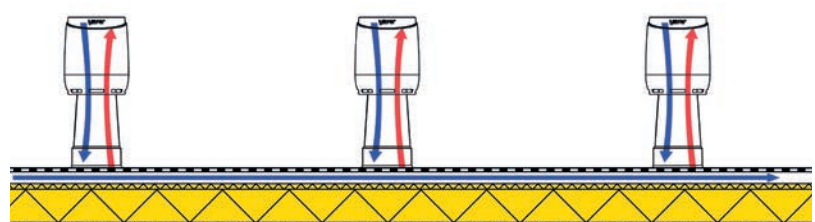

The unique structure of Alipai increases the air flow rate.



## Function and properties

The function of the Alipai negative pressure air vent is based upon the differential air pressure generated by wind. The unique structure of Alipai generates additional draught in the vent pipe which increases the air flow rate.

Alipai stands on a firm, grooved and wide flange. The patented flange shape and a novel type of grooving on both sides of the flange ensure the best possible adhesion to bitumen roofing. The width of the flange is 150 mm. The pipe size (Ø 75, 110 or 160 mm) should be selected depending on the ventilation need.

Alipai PVC collar is a cone shaped collar that allows a watertight and easy installation of the Alipai negative pressure air vent on PVC roof. The Alipai PVC collar is made of PVC plastic and is therefore installed on the PVC roof using the same welding method as the roof material. A stainless steel clamp should be used to tighten the collar around the Alipai air vent. The Alipai PVC collar ensures a waterproof end-result on a PVC roof. Alipai PVC collar is made of coloured Polyvinyl chloride (PVC).

Product	Size Ø (mm)	Height* (mm)	Colour	Product no.
VILPE Alipai 75	75	395 (P = 260)	Black	73002
VILPE Alipai FLOW 110	110	473 (P = 330)	Black	732102
			Dark grey	732107
			Light grey	732101
VILPE Alipai FLOW 160	160	509 (P = 415)	Black	730162
VILPE Alipai FLOW ridge 14	110	477 (P = 322)	Black	732132
VILPE Alipai FLOW ridge 27	110	477 (P = 322)	Black	732142
	160	396 (P = 302)	Black	730182
VILPE Alipai FLOW low-pitched/inclined	110	665 (P = 500**)	Black	732162
	160	668 (P = 560**)	Black	730172
	160	1022 (P = 924**)	Black	730202
VILPE Alipai FLOW inclined	110	699 (P = 554**)	Black	732162
VILPE PVC collar for Alipai 110	110		Dark grey	730102
			Light grey	730103
VILPE Alipai 160 insulation (6 pcs)	160			730192

\*P = pipe height from roof surface, excl. the cowl (max. height of snow)

\*\*P = if the pass-through solely is considered in the height of the product, the height is 200 mm for Alipai FLOW low-pitched/inclined and 50 mm for Alipai FLOW inclined.



VILPE Alipai FLOW low-pitched/  
inclined 110



VILPE Alipai FLOW low-pitched/  
inclined 160



VILPE Alipai FLOW low-pitched/  
inclined 160



VILPE Alipai FLOW  
inclined



VILPE PVC collar for Alipai FLOW  
110 underpressure air vent

# PASS-THROUGHS

## Felt tall pass-through

VILPE Felt tall pass-through is used for waterproof installation of VILPE P-series roof accessories on low-pitched roofs. Withdrawal ventilation pipes, roof fans and aerial sleeves should be installed on the Felt tall pass-through.

The height of the VILPE Felt tall pass-through is 200 mm, preventing water to penetrate into the structures in cases where the water level rise on the roof. The flange width is 150 mm. Felt pass-through tall is suitable for VILPE P-series ventilation pipes and roof fans with a diameter of 75-160 mm.

VILPE XL Felt Tall pass-through is used for installation of VILPE P-series XL ventilation pipes and roof fans with an inner pipe diameter of 160-250 mm. The height is 300 mm and the flange width 152/154 mm.

Note! If the duct size is 160 mm, we recommend using the VILPE XL sized P-series ventilation pipes and XL sized pass-through for better insulation.

## Installation

Waterproofing can be secured when the Felt tall pass-through is installed during the felt mounting process. The product can also be installed after felt mounting. The VILPE Felt tall pass-through and XL Felt tall pass-through are designed for installation on roofs with a pitch of less than 1:5 (11,5 degrees). The products are made of polypropylene. In contact with silicon, the material loses its functionality. The products must not be cleaned with detergents containing silicon nor must they be stored in places where silicon aerosols are used.



VILPE Felt tall pass-through



VILPE XL Felt tall pass-through

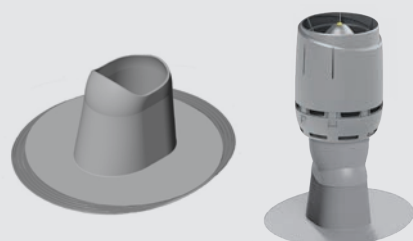

VILPE Collar PVC for Felt tall pass-through

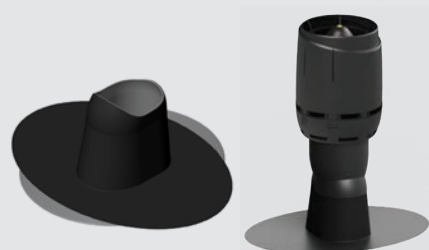

VILPE Collar EPDM for Felt tall pass-through



VILPE 315-400S FLOW pass-through with the FLOW pass-through and the steel flashing set for pass-through

Product	Colour	Product no.
VILPE Felt tall pass-through	Black	740752
	Grey	740757
VILPE XL Felt tall pass-through	Black	740052
	Grey	740057
VILPE Collar PVC for Felt tall pass-through	Grey	75703
	Light grey	75702
VILPE Collar EPDM for Felt tall pass-through	Black	75700

## 315-630S FLOW pass-throughs

### Use and size

The VILPE 315-630S FLOW exhaust vents and ready-made pass-throughs provide an excellent all-in-one solution for larger ventilation projects. The products can be used as exhaust vents in new or renovated industrial buildings, apartment buildings, hotels, sports halls, or in other large buildings with a ventilation unit. The VILPE 315-630S FLOW exhaust vents and pass-throughs come in duct sizes  $\varnothing$  315, 400, 500 and 630 mm, and are available in silver-grey, black-grey and black colour options.



## Quick and easy installation with ready-made pass-through

You can either purchase a ready-made pass-through for the VILPE 315-630S FLOW exhaust vents, or install the vents using a custom-built pass-through. The VILPE 315/400S and 500/630S pass-throughs will save you time and effort, however, as they are both easy to install and a safe choice to ensure the vent is water-tight. Since the pass-through is ready-made, the work of water-proofing with sheet metal flashings is minimised – saving both installation time and costs. The smooth bottom of the pass-through is closed and removable, so the product can be adjusted to fit most projects when connecting the pipe junction to the pass-through. A cutout is made in the baseplate for the ventilation duct. The baseplate dimensions are 495 x 495 mm for 315/400S and 740 x 740 mm for 500/630S.

## Material and construction

The pass-through is made of plywood and insulated with a 100 mm layer of stone wool. Inside, the pass-through is covered with a perforated sheet metal layer, which works as a silencer. Painted steel flashings, which cover the outside of the plywood, ensure water-tight attachment to the roof material on low-pitched roofs. The painted steel flashing set is sold separately.

The VILPE 315-630S FLOW exhaust vents are made of polyethylene, which is a light but durable material. Polyethylene is also chemically resistant and therefore does not corrode, unlike similar products made of metal.

More information about the 315-630S FLOW exhaust vents and pass-throughs, including performance data, can be found on the VILPE website:

[vilpe.com/315-630s-flow/en/](http://vilpe.com/315-630s-flow/en/)

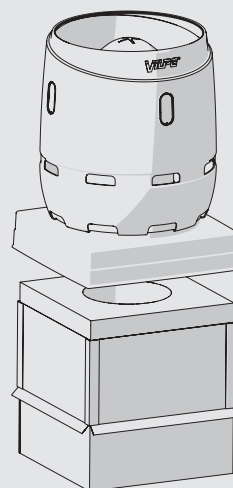
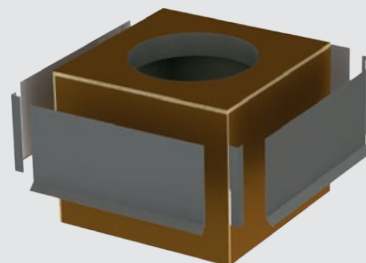
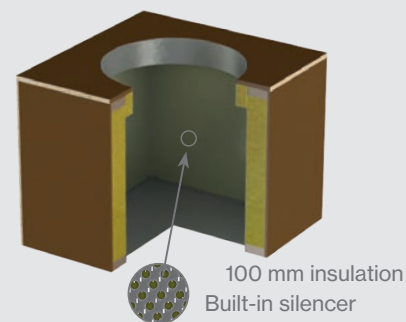

The 315/400S FLOW exhaust vent and the 315/400S FLOW pass-through

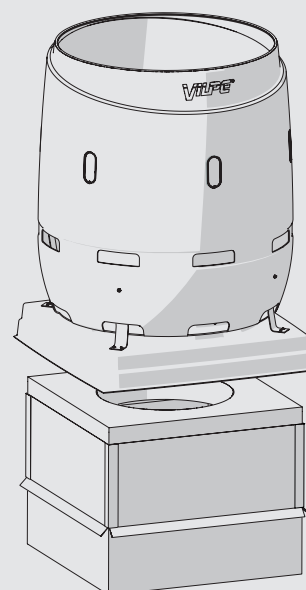

The 500/630S FLOW exhaust vent and the 500/630S FLOW pass-through

Product	Size Ø (mm)	Colour	Product no.
VILPE 315S FLOW EXHAUST VENT + INSTALLATION SET	315	Black	350402
		Black-grey	350407
		Silver-grey	350401
VILPE 400S FLOW EXHAUST VENT + INSTALLATION SET	400	Black	350412
		Black-grey	350417
		Silver-grey	350411
VILPE 500S FLOW EXHAUST VENT + INSTALLATION SET	500	Black	350432
		Black-grey	350437
		Silver-grey	350431
VILPE 630S FLOW EXHAUST VENT + INSTALLATION SET	630	Black	350442
		Black-grey	350447
		Silver-grey	350441
VILPE 315S FLOW PASS-THROUGH	315		350421
VILPE 400S FLOW PASS-THROUGH	400		350420
VILPE 500S FLOW PASS-THROUGH	500		350450
VILPE 630S FLOW PASS-THROUGH	630		350451
VILPE 315/400 FLOW STEEL FLASHING SET FOR PASS-THROUGH	315/400	Black	350423
VILPE 500/630 FLOW STEEL FLASHING SET FOR PASS-THROUGH	500/630	Black	350453

# PASS-THROUGH SEALS

## Felt pass-through seals

### Pass-through seals for low-pitched felt roofs

VILPE Pass-through seals are suitable for pass-throughs in bituminous roofs. The Felt seal product range includes round seals with the diameters of 18-875 mm. RHS seals are suitable for sealing square-shaped objects with the size 40-140 mm, while R-Felt seals are retrofitted pass-through seals for round 19-250 mm diameter objects. The clamps must be chosen according to the pipe size.

### Applications

The patented VILPE Felt and RHS seals ensure watertight joints in bitumen roofs at the installation points of vent pipes and billboard footing, antennas, flagpoles and the like.

The patented retrofitted R-Felt and RHS-Felt retrofit seals are used for sealing high objects, and objects where the installation of single-part seals is not possible.

### Function and structure

Temperature variations and winds often cause failure of watertight connections on a roof because of natural movement of the roof and pipes. The flexible EPDM rubber in the seals allow the best possible adhesion with the roofing, meaning that the product can withstand larger roof and pipe movements.

The flange of the seal provides the biggest possible adhesion area. The patented structure of the flange and proper installation methods ensure safe fixing to the bitumen and maximum sealing performance. The width of the flange is 150 mm.

In contact with silicon, the material loses its functionality. The products must not be cleaned with detergents containing silicon nor must they be stored in places where silicon aerosols are used.



VILPE Felt roof seal

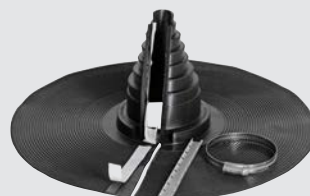

VILPE R-Felt set



VILPE RHS seal

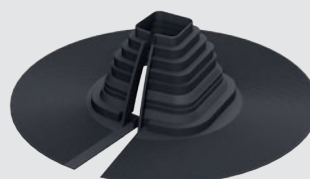

VILPE RHS-Felt retrofit seal



Product	Model / size Ø (mm)	Product no.
VILPE Felt roof seal (clamp included)	NO-1 Ø 12/19/25/38	70040
	NO-2 Ø 50/60	70060
	NO-3 Ø 75/90	70090
	NO-4 Ø 110/125	70125
	NO-4.5 Ø 130/140	70130
	NO-5 Ø 150/175	70175
	NO-6 Ø 200/250	70250
	NO-7 Ø 275/325	70325
	NO-8 Ø 350/400	70400
	NO-9 Ø 500/525/550/575	71050
	NO-10 Ø 600/625/650/675	71060
	NO-11 Ø 700/725/750/775	71070
NO-12 Ø 800/825/850/875	71080	
VILPE R-Felt set (clamp included)	19-90	70510
	110-170	70514
	160-250	70518
VILPE RHS seal*	40x40/50x50/60x60/70x70	71090
	80x80/100x100/120x120/140x140	71094
VILPE RHS-Felt retrofit 80-150*	80-150	71745

\*Clamp not included. Choose clamp according to pipe size.

## Vapour barrier seals

Pass-throughs in vapour barriers must be sealed. Vapour barrier seals (or HT seals) prevent condensed water from flowing alongside the pipe. HT seals should be used in cases where pipes run through the vapour barrier in inclined or low-pitched roofs.

### Installation

If the vapour barrier is made from bitumen, the HT seal should be fixed with bitumen. The flange of the HT seal is fixed to the vapour barrier with ventilation tape or other appropriate tape. If the underlay material is profiled sheeting, a board of a hard material should be installed on top of the vapour barrier valve before installing the HT seal. The flange should be fixed to this board. Since the upper end of the vertical part of the seal is slightly narrower, the seal will be pressed tightly against the pipe.

### Production materials

Felt, RHS, R-Felt and HT seals are made from EPDM rubber that is elastic and durable. This material is resistant to weather fluctuations, UV and ozone, as well as acids and alkali. In contact with silicon, the material loses its functionality. The products must not be cleaned with detergents containing silicon nor must they be stored in places where silicon aerosols are used.



VILPE Vapour barrier seal



VILPE Vapour barrier seal, tall



VILPE PVC roof seal

Product	Model	Size Ø (mm)	Height (mm)	Product no.
VILPE Vapour barrier seal	HT-50	50	33	71205
	HT-75	75		71207
	HT-110	110		71211
	HT-125	125		71213
	HT-160	160		71216
VILPE Vapour barrier seal, tall	HTH-110	110	133	71212

## PVC roof pass-through seals

VILPE PVC roof seals are optimal for sealing pass-throughs for round pipes on PVC roofs. Examples of applications are ventilation discharge pipes, roof poles, sewerage vent pipes, signboard or flagpole bases, aerial sleeves, the roof's external suspension tie-rods and railings. PVC roof seals are available in two sizes: 12-100 mm and 110-160 mm. The colours are dark and light grey.

### Material and installation

The PVC roof seal is made of coloured polyvinyl chloride (PVC). The seal is fastened by welding with hot air and tightened around the pipe with an included stainless steel clamp. In contact with silicon, the material loses its functionality. The products must not be cleaned with detergents containing silicon nor must they be stored in places where silicon aerosols are used.

Product	Model / size Ø (mm)	Colour	Product no.
VILPE PVC roof seal	12-100	Light grey	70601
		Dark grey	70602
	110-160	Light grey	70611
		Dark grey	70612

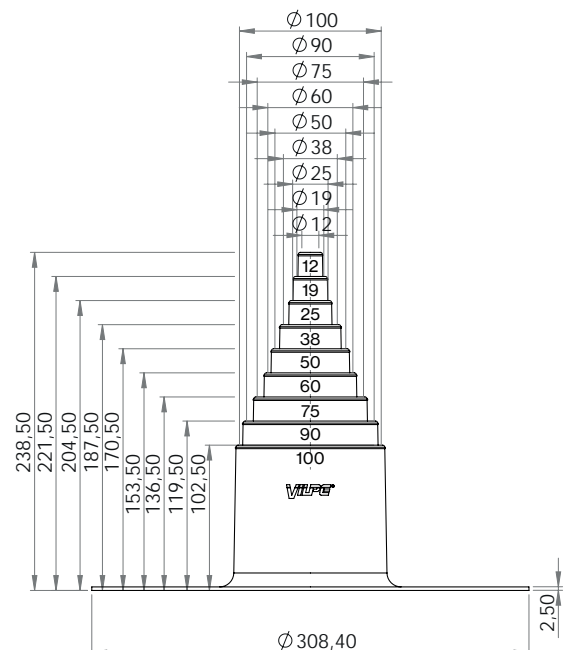



# ROOF DRAINS

Roof drains are needed on flat roofs, where rain water and melted snow is directed inwards on the roof and is discharged by the roof drains into a leader or downspout. VILPE's product range includes roof drains made of both metal and polypropylene.

The roof drains are completely waterproof. Cleaning of the drains is simple, as the leaf gratings are easy to remove. The leaf gratings are, however, when mounted very durable and stays firmly in place despite harsh winds and other external factors.

VILPE roof drains have been designed and tested in accordance with the SFS EN 1253-2 standard. The tests include mechanical stress on grating and drain, overpressure with water, underpressure with air, and flow rate measurements with and without a grating.

## Roof drains of polypropylene

The VILPE roof drain range includes two types of outlets made of polypropylene plastic, AM and CM. The AM roof drains can be installed on multiple and single-ply felt bitumen, as well as on plastic-based single-ply roofings. CM roof outlets are developed for bitumen felt roofs.

The AM roof outlets are equipped with a filter that manages larger water masses during heavy rain. The roof drain comes with two filters and therefore the same product can be used as both a siphonic and a traditional roof drain.

A 350 mm long pipe with the diameter 75, 90, 110 or 160 mm is included with the AM roof outlet. In addition, it is possible to buy a 230 V heating cable. The heating cable should be added in order to ensure that water and melted snow is transported away from the roof. A 150 mm wide flange on the AM roof outlet will secure the product to the insulation layer. The outlet is anchored to the supporting structures by the perforated flange and should be installed according to the instructions provided by the roof manufacturer.

The CM roof outlet is a traditional roof outlet for bitumen roofs. The width of the flange is 150 mm and the two-sided ribbing ensures best possible attachment to the roof. The pipe size of the roof outlet is 75 or 110 mm in diameter. The CM roof outlets are fully waterproof.

## Material

The roof drains are produced from noncorrosive, weatherproof and impact proof, recyclable polypropylene plastic (PP), which is black throughout. The plastic is also UV protected, preventing colouring defects from the sun. The material withstands the harsh strains of industry and traffic. The material is chemically neutral and withstands a constant temperature of -30°C – +80°C, and temporarily -40°C – +120°C.

The flanges of the roof drains are made of the roof materials bitumen and PVC plastics protan and alkorplan, which facilitates fastening of the drains on the roofs. In contact with silicon, the material loses its functionality. The products must not be cleaned with detergents containing silicon nor must they be stored in places where silicon aerosols are used.



VILPE AM roof outlet bitumen



VILPE AM roof outlet protan dark grey



VILPE AM roof outlet protan light grey



VILPE AM roof outlet alkorplan light grey



VILPE CM roof outlet



VILPE AM leaf grating



VILPE AM symphonic grating



VILPE CM leaf grating



VILPE Leaf grating ball

Product	Size Ø mm	Product no.
VILPE AM roof outlet bitumen	75	72007
	90	72009
	110	72011
	110/630	72012
	160	72013
VILPE AM roof outlet protan dark grey	110	72048
	160	72049
	110/630	72062
VILPE AM roof outlet protan light grey	110	72052
	160	72053
VILPE AM roof outlet alkorplan light grey	110	72044
	110/630	72045
VILPE AM thermocable 230 V / 14 W	AM roof outlets 75/90/110	72000
	AM roof outlets 160	72001
VILPE AM leaf grating	75-160	72130
VILPE AM symphonic grating	75-160	72140
VILPE CM roof outlet	75	72407
	110	72411
VILPE CM leaf grating	75	72420
	110	72422
VILPE Leaf grating ball		72424

## Acid-resistant stainless steel roof drains

VILPE's range of metal roof drains are made of acid-resistant steel (A4 / 316) and are designed to withstand even the most demanding climatic conditions. The roof drain flange is ready-primed to facilitate fastening to bitumen membranes. Metal roof drains are suitable for all gently sloping roofs. The products can also replace old roof drains, making them an excellent choice for renovation sites.

The VILPE acid-resistant stainless steel model A roof drains have a collecting basin. They are suitable for sites where water volume dimensioning requires greater flow through the roof drain, as model A roof drains have a larger filter than model C roof drains of a similar size. There is no collecting basin in model C roof drains.

The pipe sizes of the roof drains are 75, 110 or 160 mm, and different lengths are available for them, starting from 350 mm. Roof drains offer flexibility, as metal roof drains can be cut to fit the dimensions of the installation area. Note that the C-90 200 roof drain is an exception, as it is installed as-is on renovation sites.

A wide range of accessories, including heating elements, plastic leaf gratings and condensation insulation is available for metal roof drains. The builder can always tailor the whole setup to the site. Accessories can be added to roof drains at the factory during assembly, or the customer can assemble them himself.

## Water flow performance

EN 1253-2

Model	Without a grating (l/s)	With a grating (l/s)
C-75	2,2	1,8
C-110	5,3	4,8
C-160	8,2	7,8
A-75	5,7	4,5
A-110	6,1	5,7
A-160	8,2	7,9



VILPE Acid-resistant steel roof drain model A Ø 75



VILPE Acid-resistant steel roof drain model A Ø 110



VILPE Acid-resistant steel roof drain model A Ø 160



VILPE Acid-resistant steel roof drain model C Ø 75



VILPE Acid-resistant steel roof drain model C Ø 90



VILPE Acid-resistant steel roof drain model C Ø 110



VILPE Acid-resistant steel roof drain model C Ø 160

## Steel roof drains, model A

Product	Length (mm)	Product no.
VILPE Acid-resistant steel roof drain, model A Ø 75	350	390001
	600	390002
	750	390003
	1000	390004
VILPE Acid-resistant steel roof drain, model A Ø 110	350	390021
	600	390022
	750	390023
	1000	390024
VILPE Acid-resistant steel roof drain, model A Ø 160	350	390031
	600	390032
	750	390033
	1000	390034

## Steel roof drains, model C

Product	Length (mm)	Product no.
VILPE Acid-resistant steel roof drain, model C Ø 75	350	391001
	600	391002
	750	391003
	1000	391004
VILPE Acid-resistant steel roof drain, model C Ø 90	200	391011
VILPE Acid-resistant steel roof drain, model C Ø 110	350	391021
	600	391022
	750	391023
VILPE Acid-resistant steel roof drain, model C Ø 160	1000	391024
	350	391031
	600	391032
	750	391033
	1000	391034

## Accessories

Product	Model	Length (mm)	Product no.
VILPE Plastic leaf grating for model A roof drain	A-75-160		392209
VILPE Plastic leaf grating for model C roof drain	C-75		392205
	C-90		392206
	C-110		392207
	C-160		392208
VILPE Heating element for roof drain	75, 14W		392000
	110, 14W		392002
	160, 14W		392003
	160, 32W		392004
VILPE Bitumen flange for roof drain	C-75-90		392210
	C-110		392211
	C-160 / A-75-160		392212
	Cut to specific length		396000
VILPE Condensation insulation for model A roof drain	A-75	350	395001
		600	395002
		750	395003
		1000	395004
	A-110	350	395021
		600	395022
		750	395023
		1000	395024
	A-160	350	395031
		600	395032
		750	395033
		1000	395034
VILPE Condensation insulation for model C roof drain	C-75	350	395101
		600	395102
		750	395103
		1000	395104
	C-110	350	395121
		600	395122
		750	395123
		1000	395124
	C-160	350	395131
		600	395132
		750	395133
		1000	395134



VILPE Plastic leaf grating for model A roof drain



VILPE Plastic leaf grating for model C roof drain



VILPE Heating element for roof drain

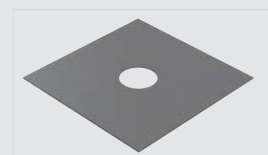

VILPE Bitumen flange for roof drain



VILPE Condensation insulation for roof drain



# FASTENERS

## Croco fasteners

Croco-512 fasteners are used to fasten roofings, insulation sheets and acoustic sheets to aerated concrete (Siporex) or lightweight aggregate concrete (Leca).

Croco A fasteners are used to fasten single-ply membrane roof covering (or insulation), while Croco B fasteners are used to fasten multi-ply roof covering (or insulation).

Croco A and Croco B fasteners can both be used when the fix-layer is steel, concrete or wood.

- Steel fix-layer: fix with a KLA Drill point screw
- Wood fix-layer: fix with a KLA Drill point screw or an Adjustable Croco screw 95
- Concrete fix-layer: fix with a Concrete screw or KLA Concrete nail, or with an Adjustable Croco screw (95 or 150)

## Alter Croco length with adjustable screws

The modern Croco A and B fasteners with adjustable screws make roof installations easier and faster, as the length of the fasteners can be easily adjusted to follow the roof slope. The risk of mounting errors decreases as the fasteners can be adjusted according to the thickness of the roofing and insulation materials. One fastener model covers a wider range of insulation thicknesses.

The adjustable screws are available in two lengths:

- Adjustable Croco screw 95 (socket 80 mm and screw 95 mm)
- Adjustable Croco screw 150 (socket 125 mm and screw 150 mm)

A T-25 (7 mm) Torx tool is used for installation. If installing the product on concrete, an M drill or similar tool is also needed, as pre-drilling is required. An M drill extension is also available. The Torx tool and the M drill with extension are sold separately.



VILPE Croco A fastener + adjustable screw

VILPE Croco B fastener + adjustable screw

VILPE Croco A fastener + Adjustable Croco screw 95. L is the length of the Croco model.

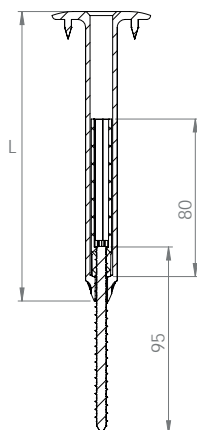

VILPE Croco A fastener + Adjustable Croco screw 150. L is the length of the Croco model.

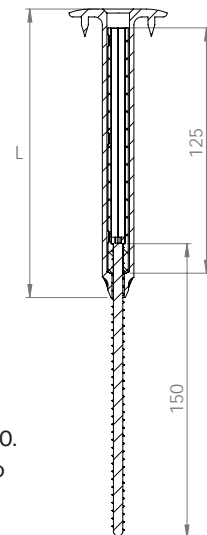

VILPE Croco 512



VILPE Croco A



VILPE Croco B

Product	Model / length (mm)	Product no.
Croco 512	00-10	054010
	10-30	054030
	30-50	054050
	50-70	054070
	80-100	054100
	100-120	054120
	120-140	054140
	140-160	054160
	180-200	054200
	230-250	054250
	280-300	054300
	330-350	054330
	380-400	054380
Croco A	20	02020
	50	02050
	80	02080
	100	02100
	120	02120
	150	02150
	170	02170
	200	02200
	230	02230
	250	02250
	300	022300
	350	022350
	400	022400
	450	022450
	500	022500
	550	022550
	600	022600
650	022650	
700	022700	
Croco B	20	02520
	30	02530
	50	02550
	80	02580
	100	02600
	110	02610
	120	02620
	140	02640
	150	02650
	170	02654
	200	02660
	230	02664
	250	02670
	260	02674
	290	02678
	300	02680
	350	02690
	400	02700
	450	02710
500	02720	
550	02730	
600	02740	

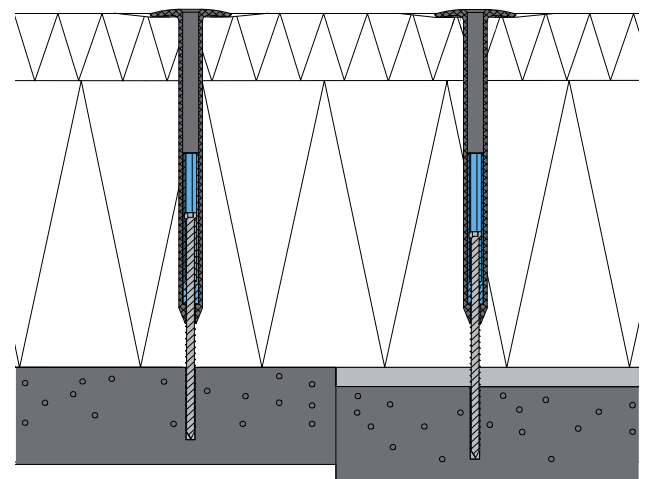
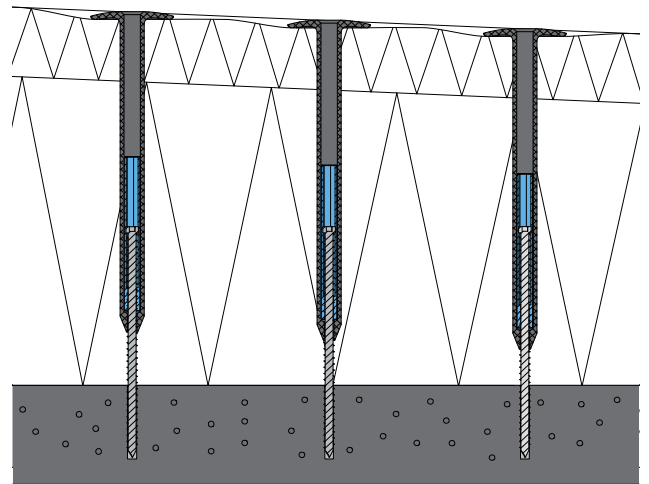
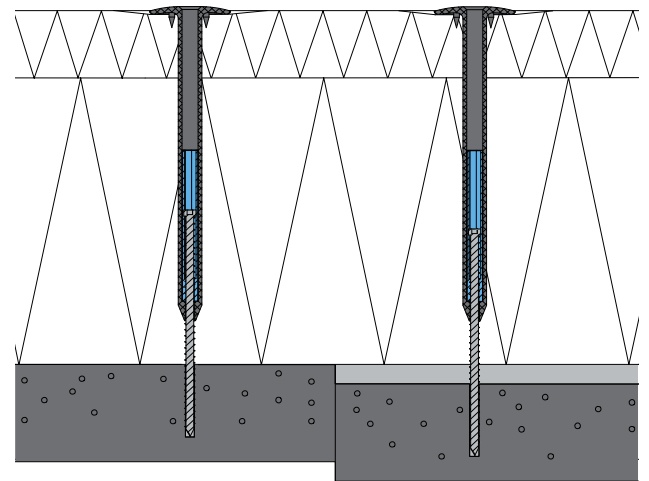
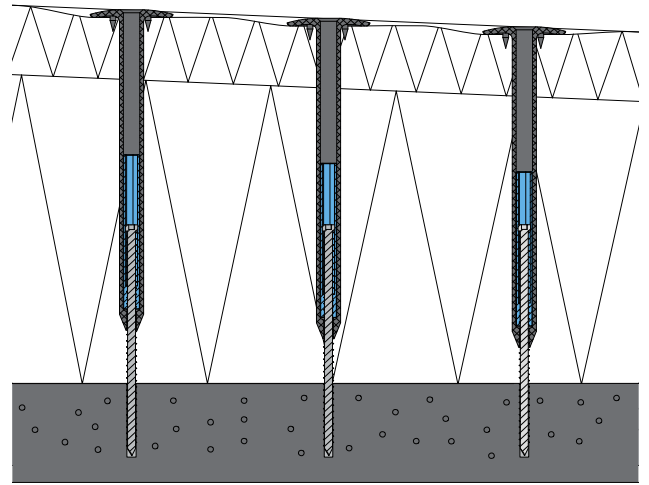

## Selection table for fasteners

Insulation mm	Croco + KLA roof screw		Croco + concrete screw	
	Croco A & B	Screw	Croco A & B	Screw
30	20	50	20	50
40	20	70	20	60
50	20	70	20	70
60	20	90	20	80
70	50	70	50	60
80	50	70	50	70
90	50	90	50	80
100	80	70	80	60
110	80	70	80	70
120	100	70	100	60
130	100	70	100	70
140	120	70	120	60
150	120	70	120	70
160	120	70	120	60
170	150	70	150	60
180	150	70	150	70
190	170	70	170	60
200	170	70	170	70
210	170	90	170	80
220	200	70	200	60
230	200	70	200	70
240	200	90	200	80
250	230	70	230	60
260	230	70	230	70
270	230	90	230	80
280	250	70	250	70
290	250	90	250	80
300	250	90	250	90
310	250	110	250	100
320	250	110	250	110
330	300	70	300	70
340	300	90	300	80
350	300	90	300	90
360	300	110	300	100
370	300	110	300	110
380	350	70	350	70
390	350	90	350	80
400	350	90	350	90
410	350	110	350	100
420	350	110	350	110
430	350	130	350	120
440	400	90	400	80
450	400	90	400	90
460	400	110	400	100
470	400	110	400	110
480	400	130	400	120
490	450	90	450	80
500	450	90	450	90
510	450	110	450	100
520	450	110	450	110
530	450	130	450	120
540	450	130	450	130
550	500	90	500	90
560	500	110	500	100
570	500	110	500	110
580	500	130	500	120
590	500	130	500	130
600	550	90	550	90
610	550	110	550	100
620	550	110	550	110
630	550	130	550	120
640	550	130	550	130
650	600	90	600	90
660	600	110	600	100
670	600	110	600	110
680	600	130	600	120
690	600	130	600	130
700	650*	90	700*	90
710	650*	110	650*	100
720	650*	110	650*	110
730	650*	130	650*	120
740	650*	130	650*	130
750	700*	90	700*	90
760	700*	110	700*	100
770	700*	110	700*	110
780	700*	130	700*	120
790	700*	130	700*	130
800	700*	150		
810	700*	150		

Compression flex should be considered under roof walkways, when installing on soft insulation and in areas where high loads are expected.

\*Only available as Croco A fasteners.

### The length of the adjustable fasteners and their suitability for different insulation thicknesses

Insulation mm	Croco mm	Adjustable screw 95 mm	Adjustable screw 150 mm
110-140	100	x	
130-160	120	x	
160-180	140	x	
170-190	150	x	
170-250	150		x
190-210	170	x	
220-240	200	x	
220-300	200		x
250-270	230	x	
280-290	250	x	
280-350	250		x
310-340	300	x	
330-400	300		x
380-450	350		x
430-500	400		x
480-550	450		x
530-600	500		x
580-650	550		x
630-700	600		x
680-750	650*		x
730-800	700*		x



## Croco tools

### Tools for Croco B and Croco A

A double-ended Torx installation bit is needed to fasten drill point screws and Croco fasteners. The length of the installation bit is chosen according to length of the fastener. We recommend that the bit is at least 30 mm longer than the fastener. 6 mm Torx tools are not recommended for adjustable Croco screws.

For the concrete Croco nails and screws, a  $\varnothing$  5 mm hole is drilled with a drill bit fastened to a drill bit extension. Standard SDS+ drills can be used with thinner insulation thicknesses. The concrete nails are installed using a blow stick and a drilling hammer.

Model	Length (mm)	Product no.
065-2X Torx bit (6 mm)*	65 (outgoing model)	910065
150-2x Torx bit (6 mm)*	150	910115
350-2x Torx bit (6 mm)*	350	910135
500-2x Torx bit (6 mm)*	500	910150
700-2x Torx bit (6 mm)*	700 (outgoing model)	910170
K-Drill 5/28		90274
K-Drill extension-400 SDS	400	90270
K-Drill extension-600	600	90272
K-Drill extension-800	800	90277
5X150/210 SDS+drill		9515206
Blow stick 600 SDS+	600 (using length 400 mm)	90238
Blow stick 800 SDS+	800 (using length 600 mm)	90240
M-Drill 5/35		90290
M-Drill 5/55		90291
M-Drill extension	750	90292
700-2X (7 mm) Torx bit adjustable	700	910180

\* Can not be used with adjustable Croco screws

### Croco-512 tools

For Croco 512 a hole of  $\varnothing$  12 mm is drilled with an edge drill to the aerated concrete (Siporex). The steel wedge of the 60-300 mm long Croco 512 -fastener is installed with a setting tool or a peg for setting tool. The steel wedge of the 250-500 mm long Croco 512 -fastener is installed with handpeg.

Model	Length (mm)	Product no.
512-Drill 12x400		90400
Setting tool 308/512 (Croco-512: 60–300 mm)		90010
Peg for setting tool (Croco-512: 60–300 mm)	320	90011
480-Handpeg (308/512) (Croco-512: 250–500 mm)	480 (total length 600)	90048

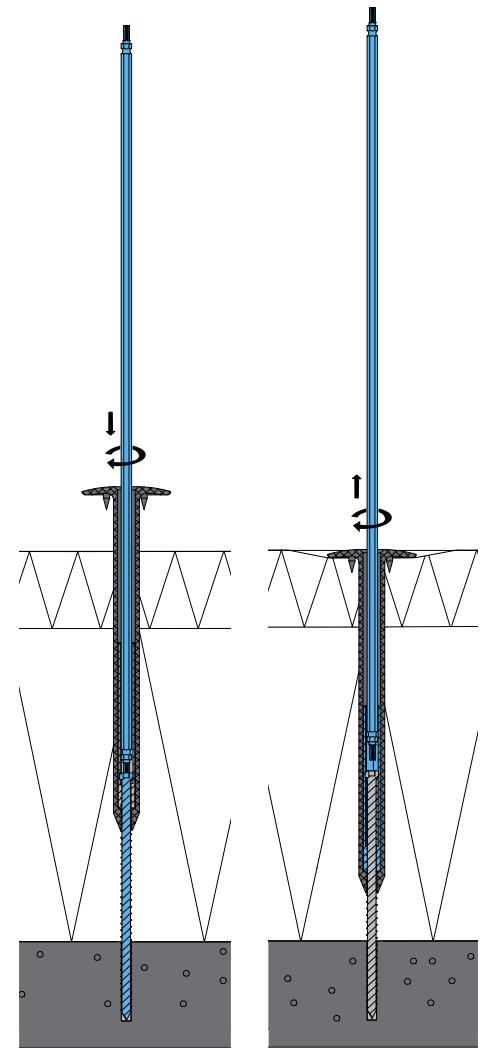

Installation of a felt roof using VILPE fasteners.



## Power fasteners

VILPE Power A is used for fastening new roof covering and insulation material to an old bitumen felt roofing or for fastening an insulation sheet to another insulation material, e.g. EPS, XPS, PIR insulation boards. The square body is stronger and prevents the tool from spinning around during the installation. In cases where there are several layers of bitumen on the roof, or if the bitumen is old and hardened, the fasteners may require pre-drilling. The drilling can be done with, for instance, an 8 mm drill or, if necessary, thicker.

Powers are installed with the square Power tool installation bit. The length of the fastener is chosen according to the insulation thickness. The Powers are made of strong polyamide (nylon) and the standard colour is black. The number of fasteners needed is determined by the results of the pull-out tests.

Dimensions: Flange Ø 50 mm, spiral size Ø 28 mm.

## Renewed Power A Adjustable - improved fastening and stronger attachment

The Power A Adjustable fastener is again available in the VILPE product selection. The fastener has been updated to ensure even better fastening and attachment. The tensile strength of the product is now improved by 15 percent in comparison to the older model.

The adjustable fastener has a margin of flexibility of 35 mm. This eliminates the need for installers to purchase multiple fastener models for varying thicknesses of insulation, as the same length can be used for multiple thicknesses. Another advantage is quicker and easier installation. The adjustable fastener is particularly suitable for sloping roofs where the installer can step on the fastener to adjust it to the correct length.

The Power A Adjustable fastener is suitable for fastening new roof covering and insulation material to an old bitumen felt roofing. By adding insulation on top of an existing roof, the insulation capacity of the roof can be increased and, if necessary, the roof slope can be improved. The fastener is also suitable for joining rigid insulation together.

The Power A Adjustable fastener is made of strong polyamide (nylon) and the standard colour is black. The product is installed using a hexagonal 350-2X Torx installation bit.

Dimensions: Flange Ø 50 mm, spiral size Ø 28 mm.

VILPE Power A



VILPE Power A Adjustable

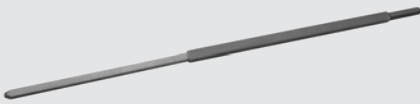

VILPE Power tool



VILPE 350-2x Torx bit

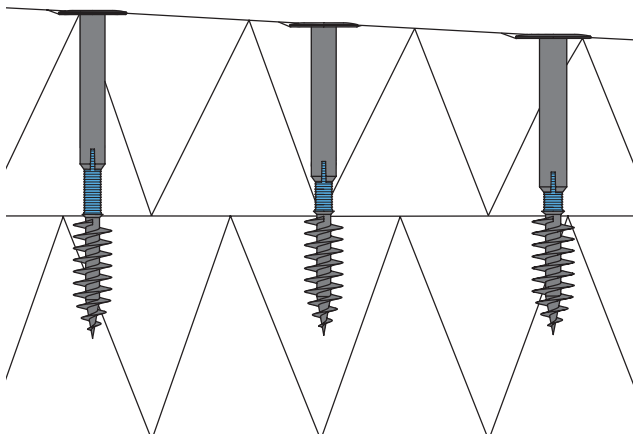

Product	Model / length* (mm)	Insulation thickness** (mm)	Insulation thickness*** (mm)	Product no.
VILPE Power A (square body)	60	00		284060
	70	00-20		284070
	90	20-40		284090
	110	40-60		284110
	130	60-80		284130
	150	80-100		284150
	175	100-120		28175
	200	130-150		28200
	225	160-170		28225
	VILPE Power A Adjustable (round body)	250	120-155	180-230
300		170-205	230-280	28300
350		220-255	280-330	28350
VILPE Power tool	POWER-350			90133
VILPE 350-2x Torx bit (6 mm)	350			910135

\* Total length of the fastener

\*\* Suitable insulation thickness when fastening to rigid insulation panel

\*\*\* Suitable insulation thickness when fastening to bituminous membrane



> [VILPE.COM](https://vilpe.com)

VILPE Oy  
Kauppatie 9  
FI-65610 Mustasaari  
Finland

Sales & technical support  
Tel. +358 20 123 3222  
sales@vilpe.com

See our installation videos on

> [youtube.com/vilpe](https://youtube.com/vilpe)

**VILPE**<sup>®</sup>  
Innovative and Easy

## VILPE Oy

The VILPE products are produced and manufactured by VILPE Oy in Finland. VILPE Oy was founded in 1975 and is a pioneer in ventilation and roofing products in Finland, Scandinavia, the Baltics and Russia. Our products improve life quality by ensuring optimal indoor air quality, lowering the risk of health problems and prolonging the lifetime of building structures. The certified VILPE products are known for their superior quality and have been developed to withstand the harshest weather conditions in North Europe.

### The highest quality standards for ventilation and roof products

Our aim is to deliver quality products in accordance with the needs of our customers. VILPE Oy has received the ISO 9001:2015 quality certificate and ISO 14001:2015 environment certificate. These certificates concern both product development, production and sales.

We are dedicated to be as environmentally friendly as we can, for instance by continuously developing more energy efficient products and using production methods that minimize environmental waste. In the VILPE factory, geothermal heating has replaced the previous oil-based system, which reduces CO<sub>2</sub> emissions by 330 tons each year. In addition, we have one of the largest solar power plants in Western Finland on the factory roof. We are committed to be a responsible actor, making the world a greener place.