

NEW!



UNIROOF roof hatch

One roof hatch for all steel and tile roofs



VILPE® UNIROOF
roof hatch comes with

20-year performance
warranty and
10-year unfading
color warranty



VILPE® UNIROOF – one product, all capabilities

The new VILPE® UNIROOF roof hatch will change your vision of roof hatches forever. From now on, the same model suits all conventional steel and tile roofs, profiles as well as all roof slopes. New underlayment sealing makes sure that modern technical and breathing underlayers will function as desired.

Thanks to use of injection molding, the final product offers uniform quality and strength in its structure. As a result of cooperation with industrial designers, the roof hatch is not only the ultimate solution technically but it also blends in well visually with any roofing.



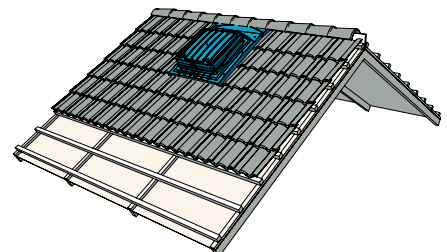
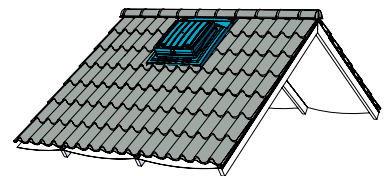
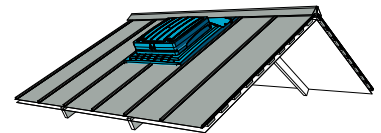

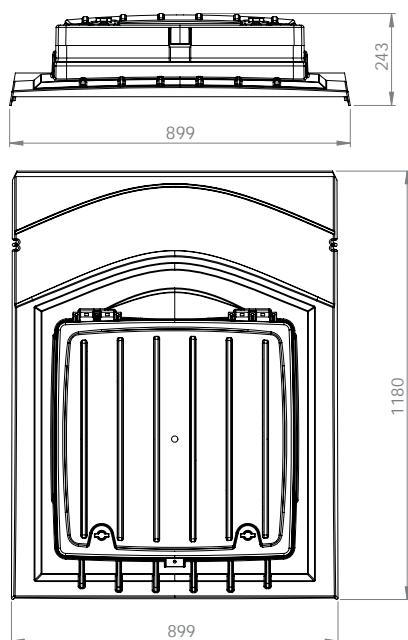

- Suitable roofing: tile, profiled steel and standing seam
- A flexible top edge facilitates installation onto the ridge of a roof
- A lockable cover
- Wide range of color options
- Easy installation
- A totally sealed solution
- Less sample storage needed
- VILPE® warranties – performance warranty of 20 years, unfading color warranty of 10 years



Dimensions



Standard colours

	Black Reference color RR 33, RAL 9005		Grey Reference color RR 23, RAL 7015
	Brown Reference color RR 32		Red Reference color RR 28/29, RAL 3009
	Green Reference color RR 11		Brick-red Reference color RR 750, RAL 8004
	Light grey Reference color RAL 7040		

Material

VILPE® UNIROOF roof hatch is produced by injection molding of through-dyed and UV resistant polypropylene (PP). This raw material is durable and has no harmful impact on the environment.

Installation

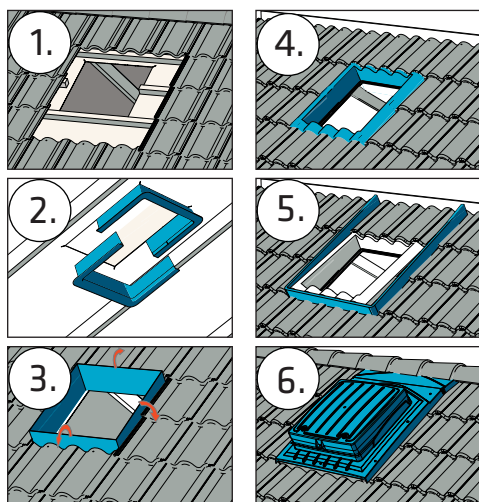

*Please see the packaging for detailed instructions!

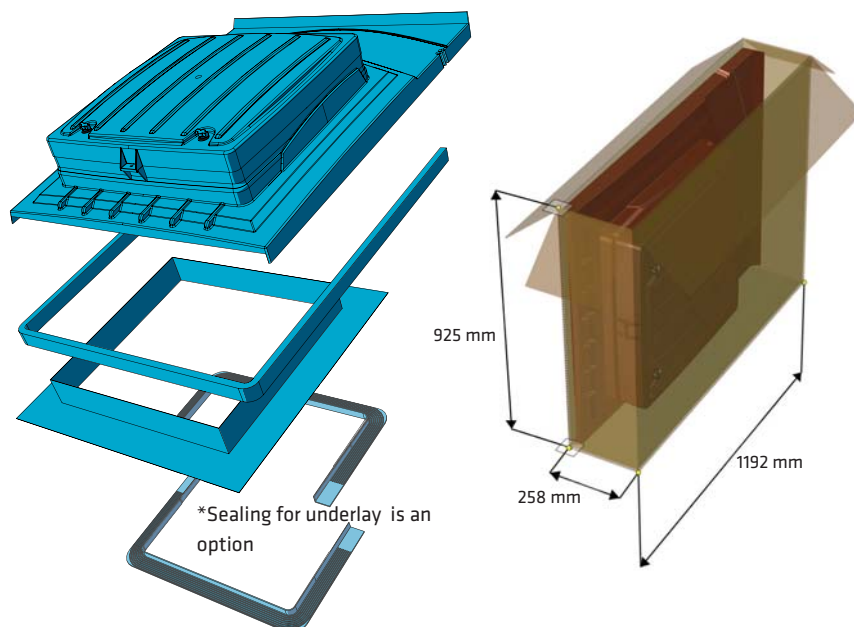

Product numbers

NAME	COLOUR	PRODUCT NUMBER
VILPE® UNIROOF -ROOF HATCH	black	738852
	brown	738854
	green	738856
	grey	738857
	red	738858
	brick-red	738859
	light grey	738851
	Also available FELT ROOF HATCH for felt roofs (Product numbers: 738842-738849)	

VILPE®-products are designed and manufactured in Finland with account taken of the northern climate conditions.